

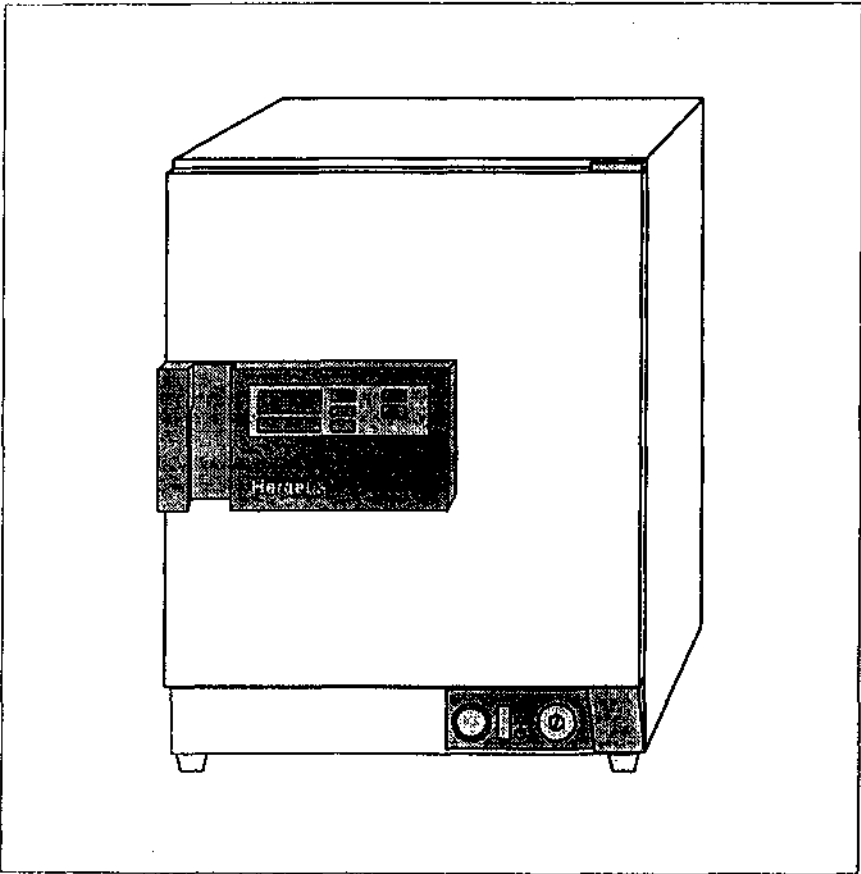

Laboratory Air Circulation Ovens

Models UT 6 P, UT 12 P, UT 20 P



Comply with the operating instructions and keep this manual in the vicinity of the unit !

 Heraeus Instruments GmbH Heraeusstraße 12 -14 D- 63450 Hanau	DD	National sales	++ (0 61 81) 35-3 00
		International sales	++ (0 61 81) 35- 4 22
		Technical support	++ (0 61 81) 35- 53 05
		National sales	++(0 61 81)35-59 73
		International sales	++ (0 61 81)35-7 49
		Technical support	++ (0 61 81) 35-8 80
		Spare parts	++ (0 61 81) 35-6 67

O Heraeus Instruments GmbH. 63450 Hanau, Germany

function line* is a registered trademark of Heraeus Instruments GmbH

The German version of this Instruction manual applies in the event of any deviations in the translation.

Nominal charge

This instruction manual applies for the following models:		
Order No.	Model	Equipment
50 042 298	UT6P	Air circulation oven, programmed controller, 1/PE AC, 230 V; 50/60 Hz
50 042 300	UT6P	Air circulation oven, programmed controller, 1/PE AC, 120 V; 50/60 Hz
50 042 306	UT12P	Air circulation oven, programmed controller, 1/PE AC, 230 V; 50/60 Hz
50 042 312	UT20P	Air circulation oven, programmed controller, 1/PE AC, 230 V; 50/60 Hz



















These heating cabinets must be operated in accordance with the instruction manual and may only be used for their intended applications in order to ensure the safety of personnel, the environment and the processed items and materials.

Read the instruction manual carefully before using the equipment and comply with the instructions that it contains to avoid making mistakes and to prevent any personal injury or damage to property.

CONTENTS

1. GENERAL SAFETY INSTRUCTIONS	4-6
Explanation of icons	4
General information	5
Operating instructions	5
Field of application	5
Safely instructions	6
2. SETUP AND INSTALLATION	7-9
Transport	7
Unpacking the unit	7
Installation	7
Room ventilation	8
Mains connection	8
Noise insulation	8
Connecting to an air extraction system	9
3. UNIT SPECIFICATION	10-17
Overview of the control elements	10
Switchgear unit	10
On / Off switch	10
Overtemperature protection device	10-11
Fresh-air flap control	11
Automatic control unit	12
Signal lamps, status function	12
Basic functions: temperature control, time switch, air speed adjustment	12
Added-feature programming functions, fixed programs	13
Fixed program segments	14
Compilation of a fixed program	14
Example of a fixed program	15
Programmed controller function	16
Termination commands	16
Example of a temperature/time program, definitions	16
What happens if... ?	17
4. OPERATION	18-28
Starting up with	
Basic functions - temperature control, time switch, blower speed adjustment	18-19
Added-feature programming functions, example	20-21
Programmed controller functions, example	22-27
Operating guidelines	28
Loading	28
Shutdown	28
5. MAINTENANCE	29-30
Decontamination / disinfection	29
Cleaning	29
Servicing	30
Tests	30
Repairs	30
Approved spare parts / accessories	30
6. TECHNICAL DATA	31-34

EXPLANATION OF ICONS

	This symbol marks chapters and sections of this instruction manual which are particularly relevant to safety. When attached to the unit, this symbol draws attention to the relevant section of the instruction manual.
	Marks information about optimum utilization of the unit in the instruction manual.
	Warns of hot surfaces.
	Key for temperature selection, time-switch function and to confirm entered information
	Key for the programming function, lime selection and to confirm entered information
	Key to set the air speed and to confirm entered information
	Value adjustment key, INCREASE VALUE
	Value adjustment key, REDUCE VALUE
	Information about proper disposal / recycling
	Overtemperature protection device
	Fresh-air flap control
	Continuous adjustment from minimum to maximum values
Quick reference guide to operation	
	Select the status of the control unit (enabled / disabled)
	Temperature control function, select temperature
	Time-switch function, sel the operating times
	Programming function
	Blower function

1 GENERAL SAFETY INSTRUCTIONS

General information

The unit fulfils the following safety standards:

DIN EN 61 010-1/03.94. VDE 0411 Part 1 / 03/94, E DIN VDE 0411 Part 111.

DIN 12 880 Part 1 /11.78 and DIN EN 60 335 - 1 , VDE 0700 Part 1

DIN EN 55 011 Part 3, DIN VDE 0875 Part 11 / 07. '92

-  Always quote the data on the rating plate when requesting information or ordering spare parts

A Operating instructions

The operator must provide anybody working on or with this equipment with written instructions for any operations to be performed. Such instructions must be easy to understand and must be available in the language of the respective personnel (FRG: UW VBG 1 § 7 (2)).

- Log book

We recommend that a log book is kept, which records any tests and calibration operations performed on the unit and any other work (repairs, modifications etc.).



Field of application

The unit has been designed as an item of laboratory equipment for technical applications.

- Heat treatment of samples or materials with operating temperatures of between room temperature + approx. 20°C and 250 °C, e.g. for drying, ageing, analysis, fusing, burning in, oxidizing, reducing, preheating, etc.
- Hot-air sterilization, sterilization by heating the article up to a temperature of at least 160 °C (FRG: also refer to DIN 58 947).
Note: The sterilization temperature usually required in the field of medical laboratory work is 110 °C.

The unit has been designed for installation and operation in the following fields:

- Laboratories, e.g. in the commercial or industrial sector, schools, universities, hospitals and biology

The unit is equipped with an independent overtemperature protection device, which means that it does not require constant supervision.

The heating unit has been designed for continuous use.

Make sure that an adequate clearance is maintained between the inside walls of the inner compartment and the loaded articles, and between the various layers of loaded articles, to prevent uneven heating of the materials.

Protective gloves, goggles etc. must be made available to the operator because of the potentially high operating temperatures.

The unit must not be used to dry or heat substances which may release combustible gases or vapours into the atmosphere, which could burn or explode when mixed with air. The heating unit is equally unsuitable for the heat treatment of combustible dusts or fibrous materials.



Safety instructions

Comply with the Instructions in this manual and keep it in the vicinity of the unit.

These units must be operated in accordance with the Instruction manual and may only be used for their intended applications in order to ensure the safety of personnel, the environment and the processed items and materials.

Read the Instruction manual carefully and comply with the instructions that it contains to avoid making mistakes and to prevent any personal injury or damage to property.

Unit must be operated by instructed personnel.

Keep unit out of reach of children.

Apart from the Instructions in this manual, the respective national regulations must also be observed for the installation and operation of this unit (FRG: ZH 1/119, DIN 12 880 Part 1).

The applicable national environmental regulations must be observed for the extraction of exhaust gases that are produced during heat treatment. Suitable measures must be implemented to ensure that such gases are safely led outside (FRG: BImSchG, UVPg, AbfG, WHG, ChemG, ...).

The unit must not be used to dry or heat substances which may release combustible gases or vapours into the atmosphere, which could burn or explode when mixed with air. The unit is equally unsuitable for the heat treatment of combustible dusts or fibrous materials.

Check the mains lead and connector for damage before using the unit. If there are any signs of damage, do not connect the unit up to the mains.

The voltage quoted on the rating plate (rated voltage) must agree with the mains supply voltage.

Protective gloves, goggles etc. must be made available to the operator because of the potentially high operating temperatures.



The surfaces around the opening of the inner compartment become hot at high operating temperatures • RISK OF BURNING - Avoid contact with these surfaces.

Ensure that the overtemperature protection device works properly by conducting a functional check at regular intervals, every 3 months at least, and check the electrical equipment at least once a year.

Any work to be conducted on the electrical equipment of the unit may only be performed by a qualified electrician. The unit must be disconnected from the mains supply before commencing service or repair work.

Only use approved accessories and approved genuine spare parts. The use of any other parts may result in unforeseen problems and should be avoided under all circumstances.

The serviceability and safety of the unit can only be guaranteed if the necessary tests, maintenance, servicing and repair work is carried out by the Heraeus service personnel or other agencies who are authorized to act on our behalf.

Heraeus Instruments GmbH cannot accept any liability for any damage that occurs as a result of improper use or repair work, which has not been performed by Heraeus service centers, or if parts other than the approved genuine spare parts / accessories are used.

2 SETUP AND INSTALLATION

Transport

Handle the unit with care. Avoid jarring and protect against damage. Do not lift by the door handle, the door itself, the control unit, the blower box, the spacer or the power lead.

Refer to the **TECHNICAL DATA** for **dimensions and weight**.

- **Unpacking the unit:**

Unpack the unit, remove the transport safety fixtures from the inner compartment and remove any dirt or dust which may have accumulated in transit.



Installation

The unit must be installed in a dry environment.

The relative humidity should be between 60 and 80 % under normal conditions.

Condensation should be avoided. If condensation has formed on the unit following a change of location or during transportation, for example, wait until the unit has dried out completely before putting into operation.

The ambient air should not contain excessive amounts of **dust**.

(Comply with the instructions in the MAINTENANCE section).

Do not cover or obstruct the ventilation or exhaust vents in the unit housing, remove any dust or dirt with a vacuum cleaner.

The ambient temperature should not exceed 40 °C.

Place the unit on a firm, fireproof surface (e.g. laboratory table, support frame) in a stable, perfectly upright position.

Keep the unit away from direct sunlight (UV radiation).

If you wish to **stack** two units on top of one another, use the **stacking frame** (available as an option). Never stack more than two units on top of one another. When stacking units of different types, make sure that e.g. an Incubator is always at the bottom, and prevent any mutual influence.

Fig. 1/2: Clearances to adjacent surfaces / objects:

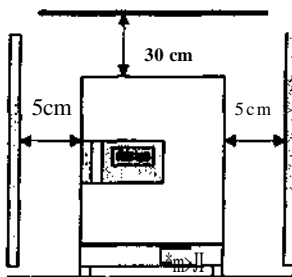

Maintain a distance from the back:

UT6P: at least 12 cm

UT12P: at least 8 cm

UT20P: at least 8 cm

The wall spacer may only be removed if the unit is connected up to an extraction system.

The exhaust gases must be led through / past adjacent surfaces / objects located above or behind the unit with heat insulation to avoid the danger of fire.

If the unit UT 6 P is to be fitted under a **table** or into a **laboratory** fixture, it must be connected to an exhaust air extraction system. The top clearance may only be reduced to min. 5 cm under such circumstances. Ensure adequate ventilation.

Types UT 12 P and UT 20 P are not suitable to be fitted under a table.

Room ventilation

Adequate ventilation must be provided wherever the unit is installed.

Do not **operate the unit in non-ventilated enclosed spaces**.

Special ventilation measures (e.g. ventilation of designated work areas, FRG: also refer to VDI 1946 Part 7) when **several units are installed in one room**.



Mains connection

The laboratory unit is supplied **with** a permanently connected, flexible mains power lead with connector (grounded).

The **connector serves to disconnect the unit from the mains power supply**.

Examine the power lead and connector for damage before using the unit. If there are any signs of damage, **do not connect the unit to the mains supply**.

The **voltage quoted on the rating plate** (rated voltage) must agree with the **nominal mains voltage**.

The unit **may only be connected up to the mains via a properly installed socket outlet with PE conductor (protection class I) or a permanent terminal connection**.

In the event of a permanent terminal connection, a master switch (lockable in the "Off" position) must also be installed to disconnect the unit from the mains.

An earth-leakage circuit-breaker should also be fitted in the supply system to provide additional protection against electric shocks.

Rubber-sheathed flexible cable of at least 2.5 mm³ diameter (H 07 RN-F ...) should be used for any extensions that may be required to connect the unit.

Refer to the TECHNICAL DATA section for the rated power consumption, circuit protection with a T 16 A fusible link or a 8 16 circuit-breaker.

Noise Insulation

The unit develops a **constant noise load**.

Refer to the TECHNICAL DATA section for the noise level.

The **unit may produce higher noise levels** in unfavorable installation conditions. **Supplementary measures may have to be implemented** to improve the sound insulation in the room.

1/ Connecting to an extraction system

Comply with the applicable national environmental regulations for the extraction of exhaust gases released during the heat treatment. Suitable measures must be implemented to ensure that such gases are safely led outside (FRG: BImSchG). Such measures may involve thermal or catalytic treatment of flue gases.

Refer to the TECHNICAL DATA section for the volume flow and temperature of the exhaust gases.

Fig. 2/2: Example of an installation

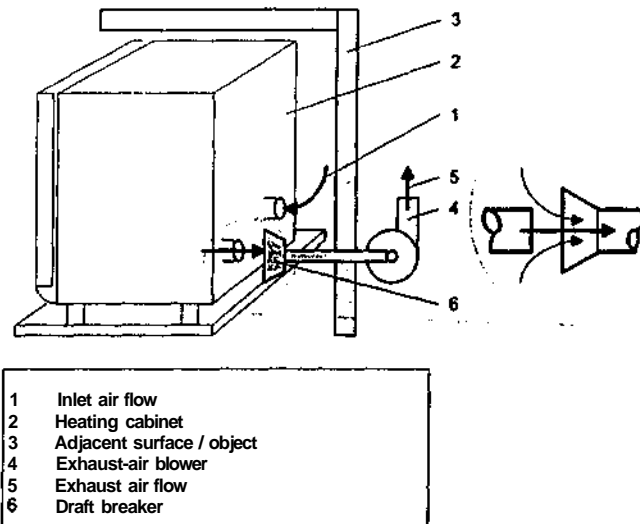

Implementation instructions:

- A draft breaker must be used to connect the unit to an extraction system.
- All flue ducts must be made of fireproof materials.
- Apertures must be provided to enable the removal of residue and condensate. The flue ducts must be thermally insulated (recommendation: half-shell sleeves made of laminated mineral fiber).
- The exhaust air / gases from the unit must never come into contact with combustion exhaust gases.
- Use the draft breaker to adjust the air flow volume in such a way that exhaust gases can be extracted reliably without producing any eddying at the unit's exhaust-gas connector.
- Technical measures should be implemented to monitor the flow of air and flue gases and to prevent operation of the heating unit if the ventilation system is switched off / defective (electrical interlock).

3. UNIT SPECIFICATION

Fig. 1/3: Overview of the control elements

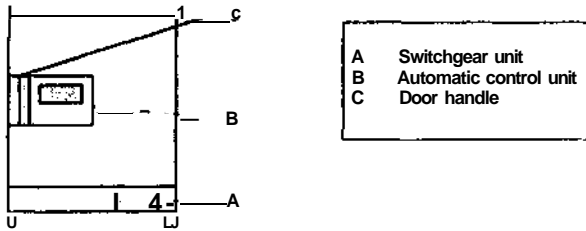

Item A: Switchgear unit

Fig. 2/3: Switchgear unit control panel

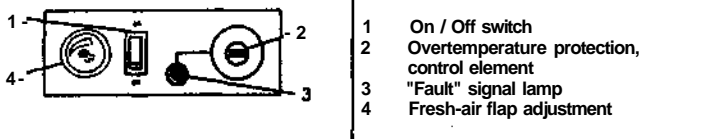

• 1 ON / OFF switch:

To switch the unit on and off:

"on" = Unit switched on, the temperature inside the unit appears on the display panel of the control unit,

"off" = Unit switched off, temperature display off.

• 2 & 3 Overtemperature protection device / signal lamp:

The unit is equipped with an electronic upper-limit cut-out device (TWB) of protection class 2 as defined by DIN 12 880 Part 1. It is electrically and functionally independent of the temperature control system. In the event of a fault in the unit heating system, the operational TWB shuts down the unit heating across all poles as soon as the temperature exceeds the preset value.

The red signal lamp indicates activation of the protection function (Fig. 2/3: Item 3).

The unit must be reset manually, by pressing the control element.

* Allow the unit to cool down (by approx. 30 °C), press the control element, the red signal lamp will go out.

The operate value is adjusted with the help of a tool (coin, screwdriver...).

Adjust to the required protection level:

• to upper temperature limit > unit protection (protects the unit and its environment).

* to approx. 10 °C higher than the operating temperature set on the control unit = material protection (protects the unit, its environment and the loaded material).



Ensure that the overtemperature protection device works properly by conducting a functional check at regular intervals, every 3 months at least, and check the electrical equipment at least once a year.

3. UNIT SPECIFICATION

- 2 & 3 Overtemperature protection device / signal lamp:



Functional test of the TWB

(Prerequisite: required working temperature (control unit) has been reached /remains constant)

Set the TWB to approx. 10 - 20 °C below the temperature displayed on the control unit. The TWB must respond, the red signal lamp indicates "Fault".

The TWB is working properly. Press the control element to release the TWB.

Now set the TWB to the temperature limit for the required type of protection.

If "Fault" is signalled during operation:

Check the settings of the TWB and the control unit and correct if necessary. If set for "material protection", this may indicate a blower malfunction. If the problem persists, contact the service center.

- 4 Fresh-air flap control

For continuous control of the fresh-air supply to the inner compartment.

- * Set to left-hand stop = minimum fresh-air supply
- * Set to right-hand stop = maximum fresh-air supply

3. UNIT SPECIFICATION

Item B: Automatic control unit

The automatic control unit contains the basic functions of a 2-position controller with PD/PID control response, time switch to switch the heating and ventilation on / off after the set time, the added features of permanently programmed heating process programs and the programmed controller functions of a freely programmable process controller.

Fig. 3/3: Control unit control panel

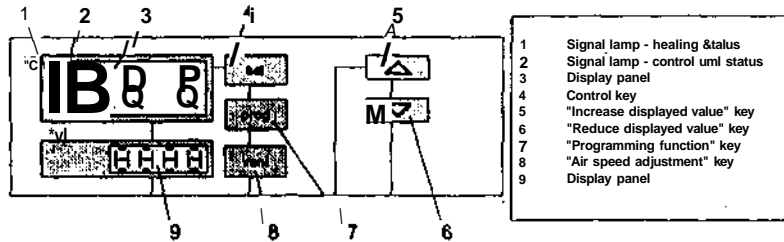

The status of the control unit is indicated by signal lamps in the display panel.

- **THE YELLOW SIGNAL LAMP** (Item 1) indicates the current status of the heating control system:

- » Lamp switched on = unit heating activated
- Lamp switched off = heating off

Rhythmic flashing of this signal lamp indicates that the temperature controller is regulating the operating temperature.

- **THE GREEN SIGNAL LAMP** (Item 2) indicates the status of the control unit:

- > **Lamp on** » control unit switched on: heating and blower enabled.
The heating and blower are activated when the unit is switched on (On / Off switch).
- **Lamp off** » control unit switched off: heating and blower disabled.
The heating and blower are not activated when the unit is switched on.
- * **Lamp flashes** * time-switch function activated.

Basic functions

The control unit is equipped with the "temperature control", "time switch" and "inside air speed adjustment" basic functions.

The unit can set an operating temperature of up to 250 °C, switching times of between 0:01 and 99:00 hours and Inside air speed in stages of approx. 40 %, approx. 70 % and 100%.

Refer to STARTING UP WITH BASIC FUNCTIONS for information about the commands for the basic functions.

3. UNIT SPECIFICATION

Added-feature programming functions, fixed programs

The control unit is capable of running heating process programs with fixed, preselected parameters from a database.

The program segment and the parameters are stored in the database.

The fixed program contains a maximum of four program segments and a status command.

Fig. 4/3: Example of a temperature/time process, controlled by the fixed program

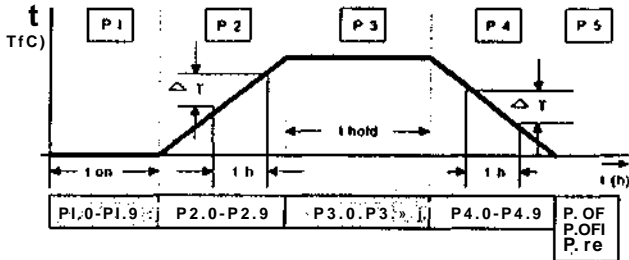

Each program segment, P 1 - P 4, is assigned to a typical temperature / time response. 10 selectable sets of parameters are permanently stored in the database for each program segment. These sets of parameters can be assigned within the program. A status command is provided as the fifth program segment. This determines the subsequent action with the program selected from the fixed program memory:

- * Program on standby, do not execute yet = Select" P. o F"
- Program on standby, wait for program start • Select" P. o n"
- Delete program from memory completely • Select" P. r E "

The program memory is erased on delivery. If the operator Interrogates the program segments, "Parameter set off" appears in the display panel = e.g. " P. I -".

When compiling a program, selecting "parameter set off" within the selected program segment causes the control unit to bypass this segment for the fixed program function.

The selected program always runs from program segment P 1. n to program segment P 4. n.

If program segment P 3. n is combined with program segment P 4. n, the heating and blower are only switched off following termination of segment P 4. n.

If a program is interrupted and started again, the sequence commences at segment P 1. n.



The previously selected operating temperature cannot be changed once the program has started.

The heating is switched off in the event of a power failure (> 20 ms) with subsequent restoration of the power supply, the temperature inside the unit is displayed as a flashing value and the program must be started again.

- Fixed program segments:

Program segment " P 1. n " (n = -, 0... 9):										
Assigning a parameter (0 ... 9) from the database causes the unit to switch on heating and ventilation on expiry of a preset period.										
Selectable parameters in this program segment:										
PI.-	PI.0	PI.1	PI.2	PI.3	PI.4	PI.5	PI.6	PI.7	PI.8	PI.9
Off	2h	4h	6h	8h	10h	12h	16h	20h	24h	72h

Program segment " P 2. n " (n = -, 0 ... 9):										
Assigning a parameter (0 ... 9) causes the unit to heat up to the preset operating temperature at a specific rate of temperature change per hour. ¹⁾										
Selectable parameters in this program segment:										
P2.-	P2.0	P2.1	P2.2	P2.3	P2.4	P2.5	P2.6	P2.7	P2.8	P2.9
off	10°C/h	20°C/h	30°C/h	40°C/h	50°C/h	60°C/h	80°C/h	100°C/h	120°C/h	200°C/h

Program segment " P 3. n " (n = -, 0... 9):										
Assigning a parameter (0... 9) causes the unit to heat up to the preset operating temperature, to maintain this temperature for the preset period and to subsequently switch off heating and ventilation										
Selectable parameters in this program segment:										
P3.-	P3.0	P3.1	P3.2	P3.3	P3.4	P3.5	P3.6	P3.7	P3.8	P3.9
off	15 min.	30 min.	1h	1.5 h	2h	4h	6h	8h	12h	24h

Program segment " P 4. n " (n = -, 0...9):										
Assigning a parameter (0... 9) causes the unit to cool down from the previously reached inside temperature at a specific rate of temperature change and to subsequently switch off heating and ventilation. ¹⁾										
Selectable parameters in this program segment:										
P4.-	P4.0	P4.1	P4.2	P4.3	P4.4	P4.5	P4.6	P4.7	P4.8	P4.9
off	1°C/h	2°C/h	5°C/h	10°C/h	20°C/h	30°C/h	40°C/h	50°C/h	60°C/h	80°C/h

1) KOORDng to nvxM »nd load

- Compilation of a fixed program

After activating the added-feature function, the sequence is compiled by marking the required program segments.

Example: Fixed program comprising P 1. 2; P 2. -; P 3. 7; P 4. 4 and P. 0 n :

P 1.-	P 1.0	P 1.1	P 1.2	P 1.3	P 1.4	P 1.5	P 1.6	P 1.7	P 1.8	P 1.9
	2h	4h	6h	8h	10h	12h	16h	20h	24h	72h
	P 2.0	P 2.1	P 2.2	P 2.3	P 2.4	P 2.5	P 2.6	P 2.7	P 2.8	P 2.9
	10°C/h	20°C/h	30°C/h	40°C/h	50°C/h	60°C/h	80°C/h	100°C/h	120°C/h	200°C/h
P 3.-	P 3.0	P 3.1	P 3.2	P 3.3	P 3.4	P 3.5	P 3.6	P 3.7	P 3.8	P 3.9
	1/4 h	1/2 h	1h	1.5 h	2h	4h	6h	8h	12h	24h
P 4.-	P 4.0	P 4.1	P 4.2	P 4.3	P 4.4	P 4.5	P 4.6	P 4.7	P 4.8	P 4.9
	1°C/h	2°C/h	5°C/h	10°C/h	20°C/h	30°C/h	40°C/h	50°C/h	60°C/h	80°C/h
P. 0 F		P. r E								

3. UNIT SPECIFICATION

- Example of a fixed program

- Example E1: Hot-air sterilization process

The heating should switch on in 8 hours, the unit should heat up to an operating temperature of 190 °C (sterilization temperature) at a rate of 200 °C/h, maintain this temperature for 4 hours (equalization phase and sterilization period) and should subsequently cool down at a rate of 20 °C/h.

The program should start following program selection (status command: P. on).

Fig. 5/3: Program profile - hot-air sterilization process E1

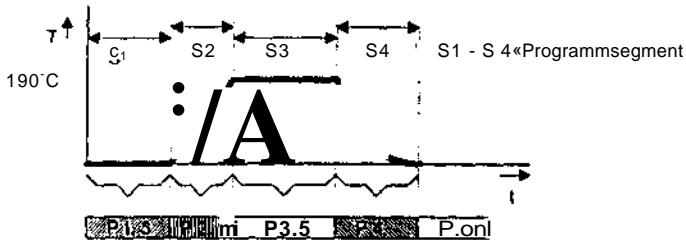

► Sequence E1:

After sketching the process characteristic, select the segments which correspond to the required sequence from the matrix .

Mark the program segments and the " P. o n" status command. Leave program Input mode. Select 190 °C as the required operating temperature. Start the fixed program.

While the program is running the display alternates between the temperature inside the cabinet and the current program segment.

Refer to STARTING UP WITH ADDED-FEATURE PROGRAMMING FUNCTIONS for further information.

Programmed controller function

The programmed controller function enables the arbitrary definition of temperature / time processes.

You may select up to 9 program segments. Operating temperature, period and air speed level can be selected for each segment.

Termination commands

A termination command can be selected as the last program segment. The termination command determines the function to be performed by the unit after running through the program.

There are three optional termination commands:

- " hold " = Once the program has terminated, the operating temperature set for the last program segment is maintained until a new operating temperature has been selected.
- * • "stOP " = Once the program has terminated, the heating and blower are switched off until the "stop" command is cancelled.
- > • "CYCL " = Once the program has terminated, it returns to the beginning and is repeated continuously until the "CYCL" command is cancelled.



A termination command must always be entered at the end of every program.

Fig. 6/3: Example of a temperature / time / ventilation program with "CYCL" termination command

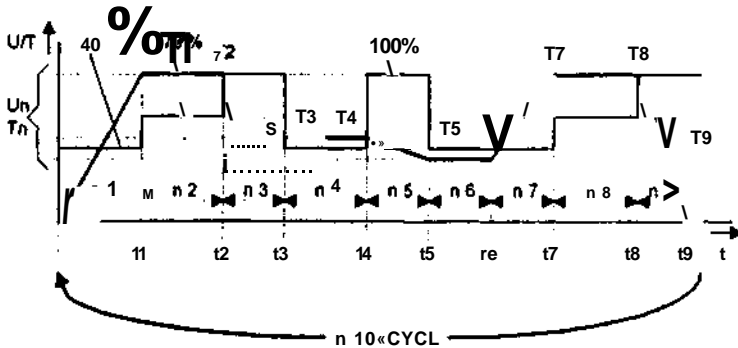

• Definitions

- n1 ... n9 Program segments
- n10 Termination commands (hold, StOP or CYCL)
- T 1 ... T9 Specified operating temperature (SO - 250 °C)
- t1 ... t9 Specified time - program segment (0:01 - 99:0 h)
- U 1 ... U 3 Specified ventilation level (approx. 40 %, approx. 70 % and 100 %)











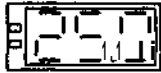

• Refer to STARTING UP WITH PROGRAMMED CONTROLLER FUNCTIONS for details.

What happens if ... ?

Possible display	Explanation
888	Control unit test phase
OFF	Status of the control unit, heating and ventilation disabled
One digit in the display flashes	The flashing value can be changed
P1.3	Program segment when entering an added-feature program function
P 1.3 alternating with inside temperature	Program segment while the added-feature program is in progress
P. o n	Status command for an added-feature program: Program on standby, wait for program start
P. OF	Status command for an added-feature program: Program on standby, do not execute yet
P. r E	Status command for an added-feature program: Delete program from memory completely
Pro alternating with inside temperature	Entered program on standby Power failure (> 20 ms) with subsequent restoration: the heating switches off, "P r o" alternates with the temperature inside the unit on the display, if a program is in progress it is interrupted and must be started again.
n l	Program segment when entering and activating the programmed controller function.
hold	Termination command when entering the programmed controller function: the temperature set for the last program segment is maintained on termination of the program
stop	Termination command when entering the programmed controller function: the heating and ventilation is switched off on termination of the program
CYCL	Termination command when entering the programmed controller function: when the program is terminated, it returns to the beginning and starts again
- - -	A termination command is entered for this program segment when entering the programmed controller function. The termination command must be changed to a time value to enable the input of a temperature value.
E-3	Stored data defective Switch the unit off and on again. If the problem persists, contact the service center
E-4	Error of measurement in the reference values - contact the service center -
E-S	Upper-limit violation of actual temperature tolerance - contact the service center -
E-6	Lower-limit violation of actual temperature tolerance - contact the service center -
E-7	Temperature sensor or input defective - contact the service center -
E-8	Stored data defective - contact the service center -
E-9	Erroneous reference values - contact the service center -

4 OPERATION

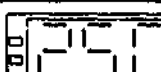
After **letup** and **Installation**, proceed as follows to start up:

Starting up with basic functions, without programming			
Instruction	Key(s)	Example of display	Remarks
Switch unit on	On / Off switch = "on"		The green status display indicates the status. Display panel: inside temperature
The unit runs through a self-test phase after switching on, display: " 888 ". If the "off" status was selected for the previous operating phase, the display alternates between the temperature inside the cabinet and the "OFF" status.			
Selecting the control unit status function			
Control unit "on": (heating and ventilation enabled)	 approx. 3 sec.		Inside temperature, green signal lamp lights up continuously
Select this status function <ul style="list-style-type: none"> ▶ to operate the unit, or ▶ to use the time-switch function to switch the heating and ventilation off after a preset period 			
Control unit "off": (heating and ventilation disabled)	 approx. 3 sec.		Inside temperature, green signal lamp remains dark
Select this status function <ul style="list-style-type: none"> ▶ to switch the heating and ventilation off, or ▶ If the heating and ventilation is to remain off during programming, or ▶ to use the time-switch function to switch the heating and ventilation on after a preset period 			
Setting the operating temperature			
Display the preset operating temperature			Preset operating temperature Display flashes
Increase the preset operating temperature			Value increases Display flashes
Reduce the preset operating temperature			Value decreases Display flashes
Store new preset operating temperature			New operating temperature is stored, then inside temperature appears on display
Unit regulates the operating temperature when status "on", yellow signal lamp indicates the status of the heating control system.			
Adjusting the overtemperature protection device: refer to Chapter 3			
Setting the position of the fresh-air flap			
>>>			











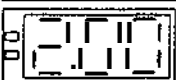

>>>			
Setting the switching time			
Instruction	Key(s)	Example of display	Remarks
Select time-switch function, display time remaining for timing period	set approx. 3 sec.		Display flashes, lime-switch function is displayed. If limiting period in progress, displays time remaining
Increase preset time			Value can be adjusted between 1 minute and 99 hours. Adjustable in full hours from 10.0 hour selling.
Reduce preset time			The heating is switched on or off, according to sel status, once timing period has expired
Store new preset time value	set		The lime value is transferred to the memory, the inside temperature then appears on the display.
The flashing status display indicates that the time-switch function has been activated .			
If you do not wish to use the time-switch function , enter 0.0 0 as the preset time .			
Selecting the air speed level			
Display the preset air speed level	vent		Preset air speed level Display flashes, speed symbol
Increase preset air speed level			Value increases (e.g. 70%/100 %) Display flashes, speed symbol
Reduce preset air speed level			Value decreases (e.g. 70 % / 40 %) Display flashes, speed symbol
Store new preset air speed level	vent		Air speed level is stored and the display then goes dark

Fig. 1/4: Example of a hot-air sterilization process

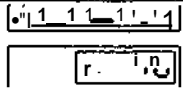

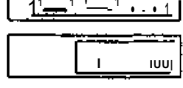
The heating is to switch on in 8 hours, the unit should heat up to 190 °C at 200 °C/h, maintain this temperature for 4 hours, then switch off.

The program should start following program selection (P. o n).

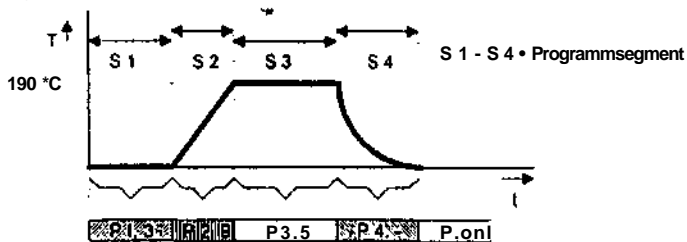
Starting up with added-feature programming functions			
Instruction	Key(s).	Example of display	Remarks
Switch unit on, select operating temperature: refer to start-up with basic functions			
Adjusting the overtemperature protection device: refer to Chapter 3			
Control unit "off", unit should not heat up during this input	approx. 3 sec.		Status display = "off", control unit is disabled, inside temperature is displayed
Call fixed program memory	approx. 6 sec.		Display flashes, program segment S1 appears after 6 sec.
Select parameter P1. 3			Programmable digit flashes. P1. is displayed if no parameter has been marked
			Programmable digit flashes
Mark P1. 3 as the required parameter in program segment S1			P1. 3 is transferred to the memory, programmable digit flashes
Select program segment S2			Programmable digit flashes
Continue in the same manner to enter / mark program segments P2. 9, P3. 5 und P4.			
>>>			







>>> Entering the status command			
Instruction	Key(s)	Example of display	Remarks
Select and mark status command P. o n			P. o n is displayed, mark with the "set" key
Leave the program memory	 		Display alternates between inside temperature and "P ro"
Input terminated			
Starting the added-feature program			
Start the program	 approx. 3 sec.		Program is started, the display alternates between the temperature and the program segment
Terminating the added-feature program			
Terminate the program	 1 sec.		Display alternates between the inside temperature and "P ro"

Fig. 2/4: Example of the programmed controller function with " STOP " termination command

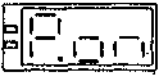

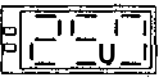



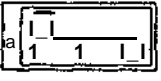
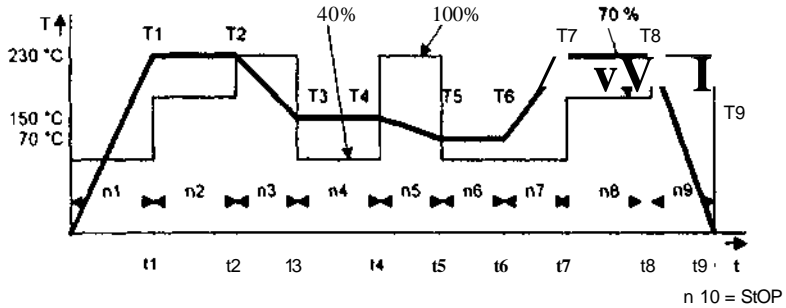









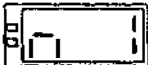

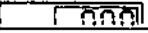





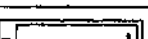





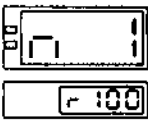

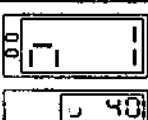
The program sequence from a total of 9 segments must be entered, after which the heating and ventilation is to be switched off.

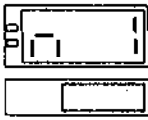
The air speed levels to be set for each program segment are given in percent.

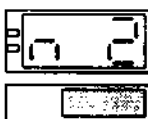
Starting up with programmed controller (unctions			
Instruction	Key(s)	Example of display	Remarks
Switch the unit on, refer to start-up with basic functions			
Adjusting the overtemperature protection device: refer to Chapter 3			
Control unit "off, unit should not heat up during this input	ca. 3 Sek.		Inside temperature, green signal lamp lights up continuously
Call main program memory	&		Program segment "n 1" is displayed, programmable digit flashes
>>>			

4 OPERATION

>>>			
Entering the temperature for a program segment			
Instruction	Key (s)	Example of display	Remarks
Enter operating temperature T 1, 230 °C	set	 	Preset operating temperature for program segment 1(n 1) flashes in display
If "—" appears in the display when the set key is pressed, then "hold" or "StOP" has been entered as the termination command for program segment n 1. If you wish to enter a temperature value, you must first change the termination command to a time value (refer to the section on "Changing the time for a program segment").			
	 or 	 	Enter 230 °C
Transfer temperature T1=230 °C to the memory	set	 	Program segment "n 1" is displayed, programmable digit flashes
Entering the time for a program segment			
Enter the time for program segment n 1, 2:00 h	prog	  	The time for n 1 flashes in the display
	 or 	  	Time t 1= 2 . 00
Transfer the preset time for program segment n 1 to the memory	prog	 	n 1 is displayed, programmable digit flashes
>>>			

>>>			
Entering the air speed level for a program segment			
Instruction	Key(s)	Example of display	Remarks
Select the preset air speed level for program segment n 1			Air speed level flashes in the display, speed symbol
	 or 		
Transfer the preset air speed level for program segment n 1 to the memory			n 1 is displayed, programmable digit flashes
Selecting the next program segment			
Select program segment n 2			n 2 is displayed, programmable digit flashes
Enter the preset operating temperatures, time values and air speed levels for program segments n 2 - n 9 in the same manner as for program segment n 1 and select program segment n 10.			
Selecting the termination command			
Select the "StOP" termination command			Termination command flashes in the display
			
Transfer the termination command to the memory			n 10 is displayed, programmable digit flashes
>>>			



Leaving the program memory			
Instruction	Key (s)	Display	Remarks
Leave the program memory	set & prog		Inside temperature is displayed
Input terminated			
Starting the program			
Instruction	Key (s)	Example of display	Remarks
Start the program	prog approx. 6 sec.		Inside temperature and program segment are displayed
Terminating the program			
Instruction	Key(s)	Example of display	Remarks
Terminate the program	1 prog 1 approx. 6 sec.		Inside temperature and control unit status are displayed

Fig. 3/4: Example of the programmed controller function with " hold " termination command

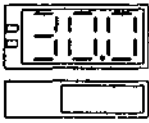

Starting up with programmed controller function			
The "hold" termination command has been selected here as an alternative to example 2/4. Enter the preset temperature, time and air speed level values for the program segments according to the same procedure as example 2/4.			
Instruction	Key(s)	Example of display	Remarks
Select program segment n 4			n 4 is displayed, programmable digit flashes
Select the "hold" termination command			Termination command flashes in the display
	or		Enter the "hold" termination command
Transfer the termination command to the memory			n 4 is displayed, programmable digit flashes
Leave the program memory and start the program			

Fig. 3/4: Example of the programmed controller function with "CYCL" termination command

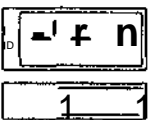
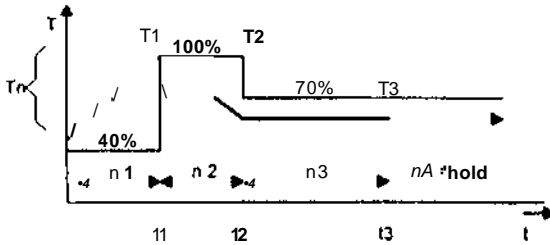
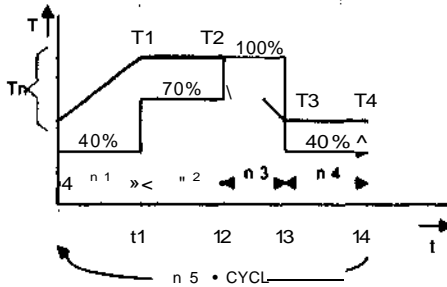

Starting up with the programmed controller function			
The "CYCL" termination command has been selected here as an alternative to example 274. Enter the preset temperature, time and air speed level values for the program segments according to the same procedure as example 2/4.			
Instruction	Key(s)	Example of display	Remarks
Select program segment n 5			n 5 is displayed, programmable digit flashes
Select the "CYCL" termination command			Termination command flashes in the display
	or		Enter the "CYCL" termination command
Transfer the termination command to the memory			n 5 is displayed, programmable digit flashes
Leave the program memory and start the program			



Operating guidelines

Remember to put on protective garments, e.g. gloves, goggles, mask, body protection, remove any items of jewellery before starting work.

Do not cover or obstruct the ventilation or exhaust vents in the unit housing. Always keep these vents free of dust and dirt.

- Loading:

Circulating air conducts the heat to the samples in the unit. Make sure that the samples are evenly distributed on the trays, and that they are arranged in such a way as to ensure an unimpeded (flow of warm air throughout the cabinet, in order to prevent local overheating. Do not position the samples too close to the inner walls.

Fig. 4/4: Loading diagram

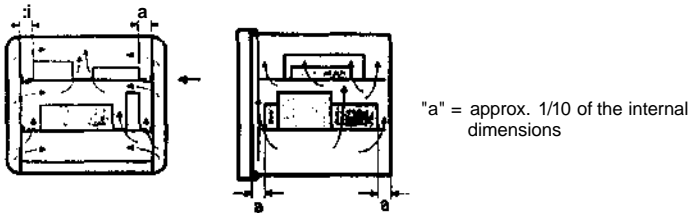

Be careful not to damage the temperature sensors in the inner chamber when loading.



Never place samples on **the floor of the chamber!**

Keep the inner surfaces of the chamber free of dust and dirt. Never use aggressive chemicals which could damage the stainless steel finish.

Continually heating and cooling the unit over wide temperature ranges can detrimentally affect its service life. If used more frequently, it is better to keep the unit running in continuous mode at moderate temperatures.



If not used for an extended period, disconnect the unit from the power supply.

Shutdown

- Remove the samples from the chamber
- Allow the heating unit to cool down to room temperature
- Switch the unit off and disconnect from the mains
- Clean the inside surfaces of the chamber
(also refer to the section on DECONTAMINATION, CLEANING ...)

 The serviceability and safety of the heating unit can only be guaranteed if the necessary tests, maintenance, servicing, and repair work is carried out by the Heraeus service personnel or other agencies who are authorized to act on behalf of Heraeus Instruments GmbH.

Heraeus Instruments GmbH cannot accept any liability for any damage that occurs as a result of improper use or repair work, which has not been performed by Heraeus service centers, or if parts other than the approved genuine spare parts / accessories are used. We recommend that you enter into a service contract with our company. Please contact us (or a quotation).



Decontamination / disinfection

The operator is responsible for implementing suitable, effective measures to decontaminate the unit if it is used in connection with hazardous materials. Such measures must be conducted on a regular basis under normal operating conditions and in particular if such materials have been spilt or before commencing service work.

The stainless steel components inside the unit may be decontaminated by wiping out with a disinfectant solution in cases of biological contamination.



Recommended disinfectant: Barrycidal 36, available from: Interchem AG, CH-6340 Baar (FRG sales: Handelsvertretung Helmut Schroder, GaufrustraBe 30/2, 70193 Stuttgart).

The applicable national regulations must be observed with respect to disinfection (FRG: ZH 1/598 ...)

Once removed, the internal stainless steel components may also be subjected to steam sterilization or autoclave treatment.

Cleaning

Use a mild soap solution (water and mild detergent) and a soft lint-free cloth to wipe the outer surfaces and control elements of the unit.

Remove any dust deposits from the air vents with a vacuum cleaner.

Remove any dust or dirt from the inner chamber. Use stainless steel cleaning agents in moderate quantities. Never use acids, chloric solvents or salt solutions to clean the stainless steel surfaces inside the unit.

Avoid scouring and scratching, or damage to labels and paintwork will be unavoidable.

Include flue/exhaust ducts in the cleaning operations if the unit is connected up to an extraction system.



Consult the manufacturer before implementing any other cleaning or disinfection measures than those mentioned in this manual to ensure that the intended methods will not damage the unit.

Serviceing

The heating unit is virtually maintenance-free.

Lubricate the bearings of the door and door-handle mechanisms with a **little synthetic oil** from time to time.

 **Mineral oil products** must not be used where they may come into contact with plastic components, as they could cause damage to such parts.



Tests

The following items should be **tested** at least once a **year to ensure that the unit remains in good working order**:

- Mechanical (unctions)
- Operation in **accordance with the specified technical data**
- Electrical **system (FRG: UVV VBG 4, OIN VOE 0701 Part 1, E DIN VOE 0702 /11.93)**
- Safety devices



Repairs

Only approved genuine **spare parts and accessories may be used**.

The use of other parts may **result in unforeseen problems and should be avoided under all circumstances**.

Approved spare **parts /accessories**

Spare part /accessory	Heraeus order number		
	UT6P	UT12P	UT20P
Size / model			
Instruction manual	SO 043 079		
Circuit diagram 1/PE AC, 230 V	SO 041 987		
Circuit diagram 1/PE AC, 120 V	SO 040 640	-	-
Wire tray with supporting straps	SO 042 916	50 042 917	50 042 918
Seasoned silicone rubber door seal	SO 042 499	SO 042 484	SO 042 351
Stacking frame	50 042 906	50 042 907	50 042 908
Space for back panel	50 028 137		
Foot	50 042 541		
Clasp for the door latching mechanism	SO 042 284		
Other spare parts and accessories to order			

6 TECHNICAL DATA

DATA	1	Model	UT6P	UT12P	UT20P	Unit
Dimensions (W x H x D)	Housing	552 x 700 X 685	696 x 850 x 685	754 x 910 x 865	mm	
	Chamber	408 X 459 x 334	552 x 610 x 334	610 x 672 x 514	mm	
	Useful space *	326 X 367 x 275	441 x 488 x 267	488 x 537 x 411	mm	
Minimum clearances to adjacent surfaces / objects	Left	50			mm	
	Right	50			mm	
	Top	300 (50 when connected to an extraction system)			mm	
	Rear	120	80	80	mm	
Volumes	Chamber (empty)	64.4	112	210	liter	
	Useful space "	33	57.6	107.8	liter	
	Steam space	approx. 73	approx. 131	approx. 234	liter	
Weights	Unit	approx. 40	approx. 55	approx. 75	kg	
Trays						
Max. tray load	Lumped	15	15	10	kg	
	Surface	20	20	15	kg	
	Total	50	50	70	kg	
Number	Standard / Max.	2/9	2/14	2/16	piece	
Dimensions	(W x D):	362 x 333	506 x 323	564 x 503	mm	
THERMAL						
Operating temperatures		Room temperature + 20 to 250				°C
Temperature deviations, circulating mode, air flap closed						
Spatial "	at 70 °C	± 0.6	± 0.7	± 1.5	K	
	at 150 °C	± 1.8	± 1.9	± 2.8	K	
	at 250 °C	± 3.4	± 3.5	± 6.0	K	
Temporal >	at 70 °C	± 0.2	± 0.2	± 0.1	K	
	at 150 °C	± 0.4	± 0.3	± 0.7	K	
	at 250 °C	± 0.7	± 0.8	± 0.8	K	
Temperature deviations, fresh-air mode, air flap open						
Spatial "	at 70 °C	± 1.3	± 0.7	± 1-7	K	
	at 150 °C	± 3.5	± 2.1	± 3.1	K	
	at 250 °C	± 5.3	± 3.5	± 5.6	K	
Temporal *	at 70 °C	± 0.2	± 0.2	± 0.2	K	
	at 150 °C	± 0.4	± 0.4	± 0.5	K	
	at 250 °C	± 1.0	± 0.8	± 1.5	K	
Warm-up times, circulating mode (unit empty, air flap closed, to 98 % of the operating temperature)						
Operating temperature	70 °C	8	8	9	min	
	150 °C	19	12	20	min	
	250 °C	42	50	60	min	

1) in accordance with DIN 12 880 Part 2/11.78



6 TECHNICAL DATA

DATA	Model	UT6P	UT12P	UT20P	Unit
THERMAL					
Warm-up-times, (resh-air mode (unit empty, air (lap open, to 98 % of the operating temperature)					
Operating temperature	70 °C	10	10	10	min
	150°C	25	20	25	min
	250°C	55	50	55	min
Cool-down times, circulating mode (unit empty, air flap closed, to 50 °C)					
Operating temperature	250°C	120	150	180	min
	150°C	90	120	140	min
	70°C	32	40	50	min
Recovery times (unit empty, door open 60 s, to 98 % of the operating temperature)					
Operating temperature	70 °C	2	1	1	min
	150 °C	5	4	4	min
	250°C	9	8	8	min
Heat radiation to surrounding areas (at a room temperature of 25 °C)					
Operating temperature	70 °C	approx. 0.16	approx. 0.18	approx. 0.2	kW
	150 °C	approx. 0.43	approx. 0.42	approx. 0.5	kW
	250°C	approx. 0.7	approx. 0.6	approx. 0.6	kW
VENTILATION					
Air volume flow inside the chamber					
Circulating mode	at 25 °C	2.7	4.7	4.8	m ³ /min
Fresh-air mode	at 250 °C	3.7	5.1	5.1	m ³ /h
Rate of air replacment					
Fresh-air mode	at 250 °C	50	40	20	h ⁻¹
Exhaust air volume flow					
Fresh-air mode	at 250 °C	6.5	10.1	10.1	m ³ /h
Speed of exhaust air		1.44	2.23	2.23	m/s
Air outlet Ø / air inlet Ø		40	40	40	mm
Flue gas temperature at duel					
	at 250 °C	250	250	250	°C
NOISE [In accordance with DIN 45 635]					
Sound level [20 µPa]		47	54	54	dB(A)
Sound power level (1 pW)		60	68	68	dB

6 TECHNICAL DATA

DATA	Model	UT6P	UT12P	UT20P	Unit
ELECTRICAL (rated values)					
Rated voltage	1/PEAC, 230				V
Rated frequency	50/60				Hz
Power consumption	1.27	2.32	2.32		KW
Connected load	1.4	2.5	2.5		kVA
Current input	5.5	10.1	10.1		A
Protection class	I				
Protective measure	PE terminal				
Degree of protection	IP 20				
Circuit protection to be provided at the installation location "	T 1\$ A fusible link (slow-blow) or B 16 circuit-breaker Connection via an earth-leakage circuit-breaker (tripping current \leq 30 mA) is recommended.				
ELCJ(CA<ra(0< values) > *					
Rated voltage	1/PEAC, 120	-	-	-	V
Rated frequency	50/60	-	-	-	Hz
Power consumption	1.27	-	-	-	kW
Connected load	1.4	-	-	-	kVA
Current Input	10.6	-	-	-	A
Protection class	I	-	-	-	
Protective measure	PE terminal	-	-	-	
Degree of protection	IP 20	-	-	-	
Circuit protection to be provided at the installation location "	T 16 A fusible link (slow-blow) or B 16 circuit-breaker Connection via an earth-leakage circuit-breaker (tripping current \leq 30 mA) is recommended.				

- 5) The applicable national electrical engineering regulations and technical requirements must be observed when connecting up to mains power supply circuits

	
Component	Materials used
Outer casing	Galvanized sheet steel, painted RAL 9002
Heat sink (rear panel)	Aluminium
Inner chamber	Stainless steel, material No. 1.4301
Components fitted in the chamber	Stainless steel, material No. 1.4301
Trays	Chromium-plated steel wire
Door seal	Seasoned silicone rubber
Door bearing	PA, glass fiber reinforced
Door handle	PA, glass fiber reinforced
Control unit	ABS
Switchgear unit	PC, glass fiber reinforced
Operator control membrane	PVS, printed polyester foil
Feet	PPN
Thermal insulation	Mineral fiber wool
Filling medium - overtemp. protection device	Polydimethylsiloxane
Leads	PVC -sheathed copper wire
Electronic / electrical components	Encapsulated components coated with various plastics, some mounted on glass fiber reinforced PCBs with epoxy resin
Heating element	Stainless steel tubing filled with magnesium oxide and heating conductors
	
<p>Fibrous materials used for insulation are classified as health hazards in some countries. Although the fibers which may be released into the environment during normal operation do not constitute a serious risk, greater, more hazardous quantities may be released as a result of improper handling during repair work or as a result of mechanical damage.</p>	



